



Explosion Proof Combination Signal - 110 dB (A) / 5 Joule

Series YL60

Contents

| | | |
|------|--|----|
| 1 | General information | 2 |
| 1.1 | Manufacturer | 2 |
| 1.2 | Information regarding the operating instructions | 3 |
| 1.3 | Further documents | 3 |
| 1.4 | Conformity with standards and regulations | 3 |
| 2 | Explanation of the symbols | 3 |
| 2.1 | Symbols in these operating instructions | 3 |
| 2.2 | Warning notes | 4 |
| 2.3 | Symbols on the device | 5 |
| 3 | Safety notes | 5 |
| 3.1 | Operating instructions storage | 5 |
| 3.2 | Safe use | 5 |
| 3.3 | Modifications and alterations | 5 |
| 4 | Function and device design | 6 |
| 4.1 | Function | 6 |
| 5 | Technical data | 7 |
| 6 | Transport and storage | 9 |
| 7 | Mounting and installation | 10 |
| 7.1 | Dimensions / fastening dimensions | 10 |
| 7.2 | Mounting / dismounting, operating position | 11 |
| 7.3 | Installation | 21 |
| 8 | Commissioning | 21 |
| 9 | Operation | 22 |
| 9.1 | Troubleshooting | 22 |
| 10 | Maintenance, overhaul, repair | 22 |
| 10.1 | Maintenance | 23 |
| 10.2 | Repair | 23 |
| 10.3 | Returning the device | 24 |
| 11 | Cleaning | 24 |
| 12 | Disposal | 24 |
| 13 | Accessories and spare parts | 24 |

1 General information

1.1 Manufacturer

R. STAHL Schaltgeräte GmbH
 Business Unit Lighting & Signalling
 Nordstr. 10
 99427 Weimar
 Germany

Phone: +49 3643 4324
 Fax: +49 3643 4221-76
 Internet: www.r-stahl.com
 E-mail: info@stahl.de

R. STAHL Schaltgeräte GmbH
 Am Bahnhof 30
 74638 Waldenburg
 Germany

Phone: +49 7942 943-0
 Fax: +49 7942 943-4333
 Internet: www.r-stahl.com
 E-mail: info@stahl.de



1.2 Information regarding the operating instructions

ID-No.: 222936 / YL6060300020
 Publication Code: 2018-04-13-BA00-III-en-01

The original instructions are the English edition.
 They are legally binding in all legal affairs.

1.3 Further documents

- Data sheet





For documents in additional languages, see www.r-stahl.com.





1.4 Conformity with standards and regulations

See certificates and EU Declaration of Conformity: www.r-stahl.com.
 The device has IECEx approval. For certificate please refer to the IECEx homepage:
<http://iecex.iec.ch/>

2 Explanation of the symbols

2.1 Symbols in these operating instructions



| Symbol | Meaning |
|---|---|
|  | Tips and recommendations on the use of the device |
|  | General danger |
|  | Danger due to explosive atmosphere |
|  | Danger due to energised parts |

-  = Strobe
-  = Sounder
-  = Earth
-  = Sounder Tone
-  = Telephone initiate





2.2 Warning notes

Warnings must be observed under all circumstances, in order to minimize the risk due to construction and operation. The warning notes have the following structure:

- Signalling word: DANGER, WARNING, CAUTION, NOTICE
- Type and source of danger/damage
- Consequences of danger
- Taking countermeasures to avoid the danger or damage

| | |
|---|---|
|  | DANGER |
| | Danger to persons Non-compliance with the instruction results in severe or fatal injuries to persons. |
|  | WARNING |
| | Danger to persons Non-compliance with the instruction can result in severe or fatal injuries to persons. |
|  | CAUTION |
| | Danger to persons Non-compliance with the instruction can result in light injuries to persons. |
| NOTICE | |
| Avoiding material damage Non-compliance with the instruction can result in material damage to the device and / or its environment. | |

2.3 Symbols on the device

| Symbol | Meaning |
|---|---|
|  0158 <small>05594E00</small> | CE marking according to the current applicable directive. |
|  02198E00 | According to marking, device certified for hazardous areas. |
|  15649E00 | Input |
|  15648E00 | Output |

3 Safety notes



3.1 Operating instructions storage

- Read the operating instructions carefully and store them at the mounting location of the device.
- Observe applicable documents and operating instructions of the devices to be connected.

3.2 Safe use

- Read and observe the safety notes in these operating instructions!
- Observe characteristic values and rated operating conditions on the rating and data plates!
- Observe additional information plates on the device!
- Use the device in accordance with its intended and approved purpose only!
- We cannot be held liable for damage caused by incorrect or unauthorized use or by non-compliance with these operating instructions.
- Before installation and commissioning, make sure that the device is not damaged!
- Work on the device (installation, maintenance, overhaul, repair) may only be carried out by appropriately authorized and trained personnel.

3.3 Modifications and alterations

| | |
|---|--|
|  | DANGER |
| | Explosion hazard due to modifications and alterations to the device! Non-compliance results in severe or fatal injuries. <ul style="list-style-type: none"> • Do not modify or alter the device. |
|  | No liability or warranty for damage resulting from modifications and alterations. |

4 Function and device design

| | |
|---|--|
|  | DANGER |
| | <p>Explosion hazard due to improper use! Non-compliance results in severe or fatal injuries.</p> <ul style="list-style-type: none"> • Use the device only according to the operating conditions described in these operating instructions. |

4.1 Function

The explosion proof combination signal series YL60 is an audible and visual signal. It provides an audible and/or visual signal intended to alert, warn or draw attention to an event. It is designed for use in hazardous or harsh environments. In hazardous areas the devices have explosion protection for ATEX / IECEx Zones 1 & 2 for gas and 21 & 22 for dust. Gas groups covered are IIB & IIB + H2, dust protection for IIIC. UL certified variants offer protection to Class I Division I Gas groups BCD, Class II Division I Gas groups EFG.

The device is not intended for continuous use.

The life of the xenon flash tube is guaranteed for the following number of flashes:

| Variant | Number of flashes |
|---------|-------------------|
| 5 J | 2 million |

5 Technical data

Explosion Protection

Global (IECEx)

Gas and dust

| | |
|-------------|---|
| IIB+H2 | IECEx BAS 05.0087X |
| IIB | IECEx BAS 05.0086X |
| IIB+H2, IIB | IEC 60079-0: 2011 / IEC 60079-1: 2007-04 / IEC 60079-31: 2008 |
| IIB+H2 | Ex d IIB+H2 T4 Gb (Ta = -20 ... +60 °C) Ex tb IIIC T135 °C Db IP 66 (Ta = -20 ... +60 °C) Ex d IIB+H2 T6 Gb (Ta = -20 ... +40 °C) Ex tb IIIC T85 °C Db IP 66 (Ta = -20 ... +40 °C) |
| IIB | Ex d IIB T4 Gb (Ta = -35 ... +60 °C) Ex tb IIIC T135 °C Db IP 66 (Ta = -35 ... +60 °C) Ex d IIB T6 Gb (Ta = -35 ... +40 °C) Ex tb IIIC T85 °C Db IP 66 (Ta = -35 ... +40 °C) |

Europe (ATEX)

Gas and dust

| | |
|-------------|---|
| IIB+H2 | Baseefa02ATEX0222X |
| IIB | Baseefa02ATEX0212X |
| IIB+H2, IIB | EN 60079-0: 2009 / EN 60079-1: 2007 / EN 60079-31: 2009 |
| IIB+H2 | ⊕ II 2 G Ex d IIB+H2 T4 Gb (Ta = -20 ... +60 °C) ⊕ II 2 D Ex tb IIIC T135 °C Db IP 66 (Ta = -20 ... +60 °C) ⊕ II 2 G Ex d IIB+H2 T6 Gb (Ta = -20 ... +40 °C) ⊕ II 2 D Ex tb IIIC T85 °C Db IP 66 (Ta = -20 ... +40 °C) |
| IIB | ⊕ II 2 G Ex d IIB T4 Gb (Ta = -35 ... +60 °C) ⊕ II 2 D Ex tb IIIC T135 °C Db IP 66 (Ta = -35 ... +60 °C) ⊕ II 2 G Ex d IIB T6 Gb (Ta = -35 ... +40 °C) ⊕ II 2 D Ex tb IIIC T85 °C Db IP 66 (Ta = -35 ... +40 °C) |

North America (cULus listed)

Gas and dust

| | |
|-------------|--|
| IIB+H2, IIB | E161818, E188831 |
| IIB+H2, IIB | SL: UL 60079-0 / UL 60079-1 / UL 1203 / UL 1638 CSA C22.2 No. 30-M1986 / CSA C22.2 No. 25-M1966 / CSA E60079-0-7 / CSA E60079-1 |
| IIB+H2 | CLASS I, DIVISION 1, GROUPS B, C and D, T4; CLASS II, DIVISION 1, GROUPS E, F and G; CLASS III CLASS 1, ZONE 1 AEx d IIB+H2 T4 CLASS 1, ZONE 1 Ex d IIB+H2 T4 Operating temperature -25 ... +66 °C Audible signal appliance public mode with supplementary Visual signal appliance private mode |
| IIB | CLASS I, DIVISION 1, GROUPS C and D, T4; CLASS II, DIVISION 1, GROUPS E, F and G; CLASS III CLASS 1, ZONE 1 AEx d IIB T4 CLASS 1, ZONE 1 Ex d IIB T4 Operating temperature -35 ... +66 °C Audible signal appliance public mode with supplementary Visual signal appliance private mode |

Explosion Protection

Certifications and certificates

| | |
|--------------|--|
| Certificates | IECEX, ATEX, Brazil (INMETRO), India (PESO), Kazakhstan (TR), Russia (TR), Taiwan (ITRI), USA & Canada (cULus), Belarus (TR) |
|--------------|--|

Technical Data

Technical data

| | |
|----------------|------|
| Product weight | 6 kg |
|----------------|------|

Electrical data

| | | |
|---------------------------|---|--------|
| Rated operational voltage | 24 V DC, 48 V DC, 115 V AC and 230 V AC operational parameters + or -10 % | |
| Rated operational current | 24 V DC | 570 mA |
| | 48 V DC | 435 mA |
| | 115 V AC | 200 mA |
| | 230 V AC | 100 mA |

Mechanical data

| | |
|----------------------|--|
| Material | |
| Enclosure | aluminium, seawater resistant |
| Horn | ABS, flame retardant |
| Lens cover | polycarbonate |
| Fixings | stainless steel |
| Cable entries | 2 cable entries, equipped with stopping plug (1x) and dust cap (1x) UL devices: equipped with M20 / 1/2 " adapters (2x) |
| Degree of protection | IP66 – IEC 60529 NEMA 4X – UL 50 |

Operating temperature range

Variant dependant see Explosion protection

Technical Data

Acoustic data

Volume 110 dB(A) / 1 m

Polar diagram

Horizontal plane

Vertical plane

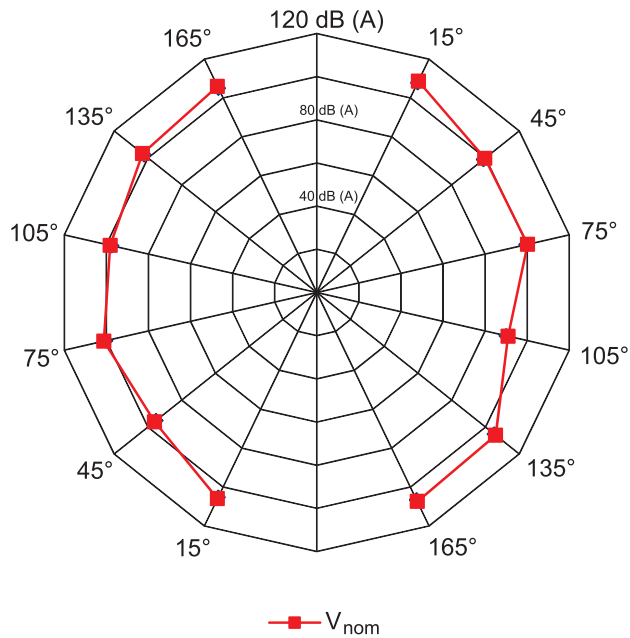

15288E00

Luminous characteristics

| | | |
|-------------------|---------|-----------------------|
| Effective candela | 5 J | |
| | Clear | 46 cd |
| | Yellow | 42 cd |
| | Amber | 28 cd |
| | Red | 14 cd |
| | Blue | 13 cd |
| | Green | 10 cd |
| | Magenta | N/A |
| Candela seconds | 5 J | 9.3 lumens Clear lens |
| Flash energy | 5 J | |
| Flash rate | 60 FPM | |

For further technical data, see www.r-stahl.com.

6 Transport and storage

- Transport and store the device only in the original packaging.
- Store the device in a dry place (no condensation) and vibration-free.
- Do not drop the device.

7 Mounting and installation

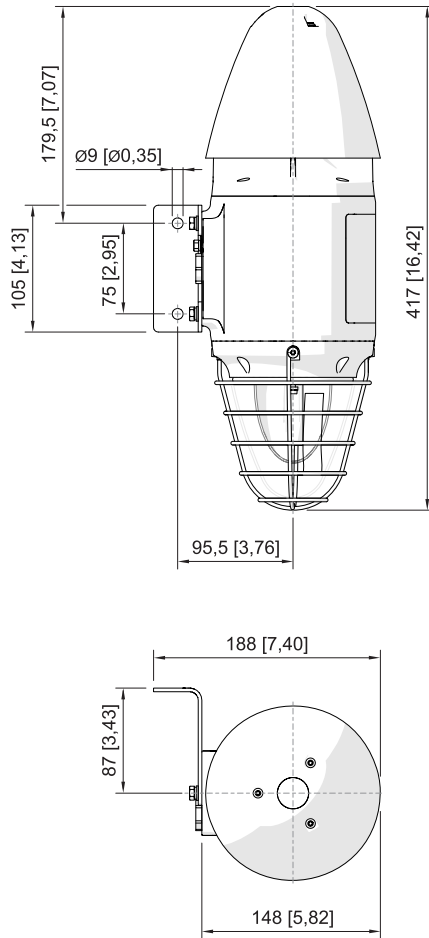

7.1 Dimensions / fastening dimensions

Dimensional Drawings (All Dimensions in mm [inches]) – Subject to Alterations





18380E00

7.2 Mounting / dismantling, operating position

| | |
|---|--|
|  | DANGER |
| | <p>Risk of explosion! Risk of injuries and material damage!</p> <ul style="list-style-type: none"> Terminal sleeves are fitted, they must be gas-tight and applied with a suitable tool. |
|  | DANGER |
| | <p>Explosion hazard! Risk of injuries and material damage!</p> <ul style="list-style-type: none"> Carefully remove or replace the components. Exposed joint surfaces must not be damaged and must be protected from dust and dirt. Install the end flanges squarely without applying any force. Do not use a hammer or other tools when working on the flanges and do not use the fixing screws to pull down the flanges. |

- Mount the device on a flat surface suitable for its weight.
- The tone output should be directed towards the area to be covered (see chapter Technical Data, Polar diagram).
- Insert the cables using certified and flameproof cable glands which are suitable for the gas group.
- Close unused entries using certified and flameproof stopping plugs.

7.2.1 Installation conditions for electrical connection

| | |
|---|---|
|  | DANGER |
| | <p>Explosion hazard! Risk of injuries and material damage!</p> <ul style="list-style-type: none"> Only use cable glands with corresponding certificate. The cable glands must be flameproof (Ex d) and suitable for the type of cable used. Close unused open holes in the enclosure with flameproof stopping plugs. Close unused cable glands using flameproof plugs. Cable glands, stopping plugs and plugs must meet the requirements of IEC/EN 60079-14. Installation of the cable gland must be performed in accordance with the manufacturer's instructions. Cable entry temperature may exceed 70 °C. To ensure degree of protection IP 66, a non-hardening sealant must be applied to the threads. |
|  | DANGER |
| | <p>Danger due to energised parts! Non-compliance results in severe or fatal injuries.</p> <ul style="list-style-type: none"> Before opening and dismantling the device, disconnect it from the power supply. Secure the device against unauthorized switching. |

7.2.2 Access to the PCB

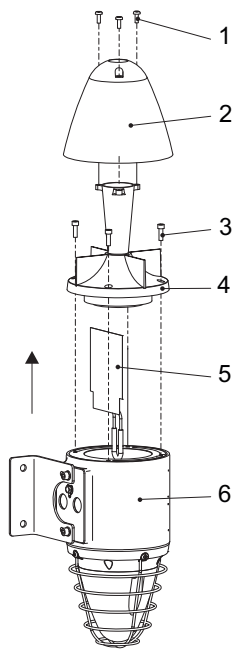

15256E00

- 1 Screws ST 4,2 x 13
- 2 Horn cover
- 3 Cheese-head screws M5 x 16
- 4 Sounder flange
- 5 PCB
- 6 Enclosure

- Remove the 3 screw ST 4,2 x 13
- Lift horn cover
- Remove the 4 cheese-head screws M5 x 16
- Lift sounder flange
- Disconnect pressure unit from PCB (see Electrical Connection, Key Components)
- Lift PCB to expose terminals for connection
(see Electrical Connection, Wiring Diagrams for details)

7.2.3 Reassembly of enclosure Inserting the PCB

For correct positioning of the PCB there are 2 grooves in the enclosure. Depending on the version, insert the PCB in the corresponding groove!

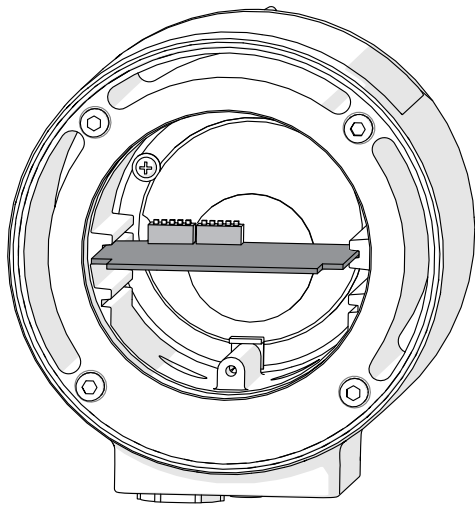

18814E00

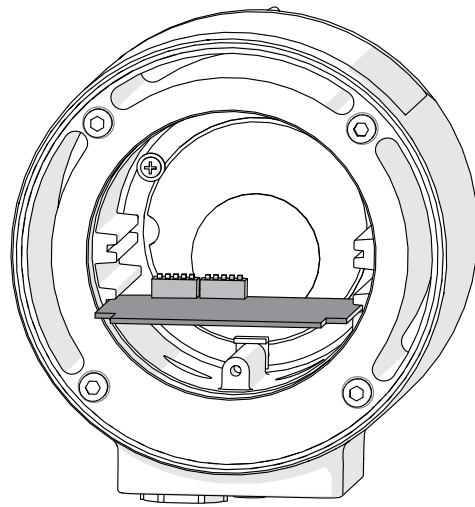

18813E00

- YL60./D50./..
- YL60./F50./..
- YL60./L50./..
- YL60./N50./..
- Carefully insert the connected printed circuit board.
- Connect the horn flange to the printed circuit board.
- Set the horn flange on the enclosure. Do not clamp in any cables in the process.
- Insert the horn flange in a straight position without applying any pressure.
- Replace cheese-head screws M5 x 16 (see information below) and tighten the screws with a tightening torque of 3 Nm.
- Re-attach the cover. Tighten the ST 4.2 x 13 screws with a tightening torque of 0.4 Nm.



- Carefully assemble the device to ensure that the degree of protection is IP 66.
- The cheese-head screws are delivered with Nyltite seals (see the "Connection" section above).
- Check the Nyltite seals for damage before the installation.
- Tighten cheese-head screws with a torque of 3 Nm.
- Use the Nyltite seal a maximum of five times with the tightening torque.

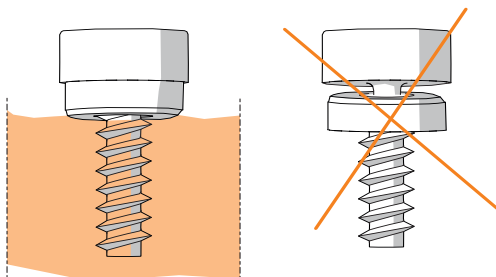

15748E00

7.2.4 Electrical connection

Key Components

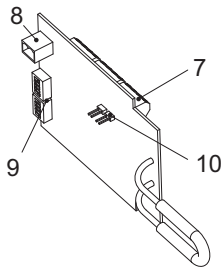

15257E00

Key components YL60 DC

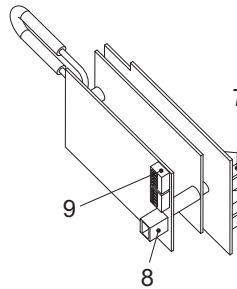

15258E00

Key components YL60 AC

Legend

- 7 = Terminal blocks
- 8 = Connector for sounder
- 9 = Tone selection switch (ton table)
- 10 = Link for combined function (DC-version only)

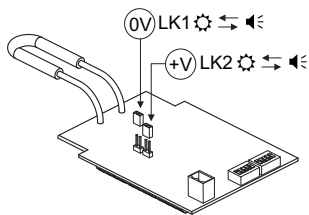

15268E00

Link connected:

- Strobe and sounder work together.

Link removed:

- Strobe and sounder independent function.

⚙ = Strobe

🔊 = Sounder

Cable Connection

| | |
|---|---|
|  | <ul style="list-style-type: none"> • Approximately 20 cm (8 Inch) tails are required inside the enclosure for connection to the terminals on the PCB. This is especially important for installation using solid core cable. • The terminals accept wires of 2.5 mm² or 14 to 18 AWG. |
|---|---|

Interconnection of devices parallel

Up to 10 devices with common supplies may be connected as a single system loop.

Circuit diagrams

| | |
|----------|---|
| i | <p>Line monitoring for devices with DC</p> <ul style="list-style-type: none"> • Through reverse polarity • By connecting an EOL resistor between 0 V and +V. The resistance value is defined by the system developer. |
| i | <p>Two signal levels for devices with DC</p> <ul style="list-style-type: none"> • Through reverse polarity • By connecting a third electrical line. <p>Two signal levels for devices with AC</p> <ul style="list-style-type: none"> • By connecting a third electrical line. |

DC version

Combined function of sounder and strobe with one signal tone

Connection to a 2-wire conductor

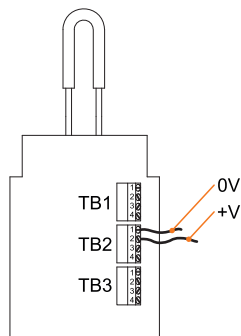

18400E00

Combined function of sounder and strobe with two signal tones

Connection to a 3-wire conductor

Tone 1

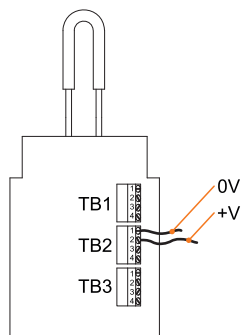

18400E00

Tone 2

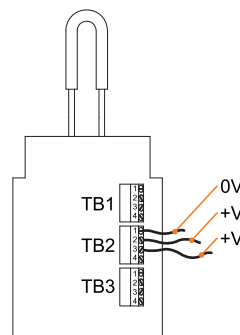

18402E00

Connection to a 2-wire conductor - second tone by reverse polarity

Tone 1

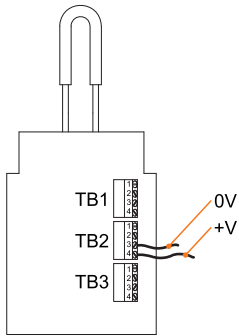

18403E00

Tone 2

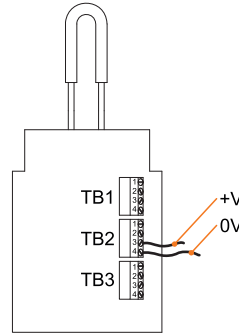

18404E00

Independent function of sounder and strobe
Connection to a 4-wire conductor

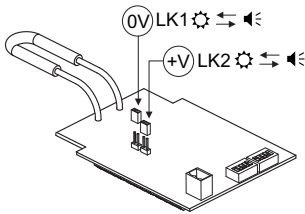

15266E00

Remove jumper from LK1 and LK2

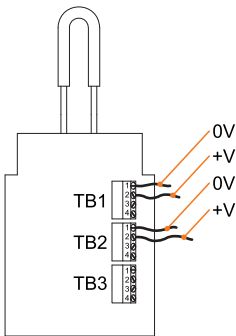

18401E00

Connection:

- Strobe TB1
- Sounder TB2

Second tone by reverse polarity or 3-wire connection to TB2, as shown above in connection diagrams.

Combined function of sounder and strobe - activation by telephone signal

Sounder and strobe are activated by a telephone signal. The function is retained as long as the telephone signal is available. The strobe can flash up to four times after deactivating the telephone signal.

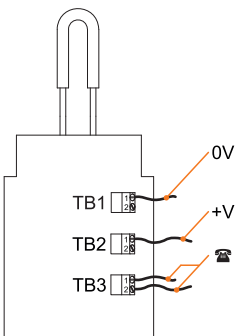

18414E00

AC version

Combined function of sounder and strobe with one signal tone

Connection to a 2-wire conductor

Bridge TB1 and TB2 using a conductor.

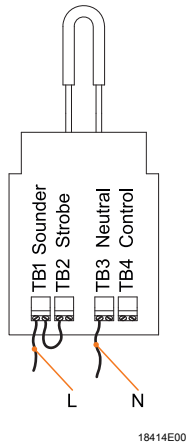

Combined function of sounder and strobe with two signal tones

Connection to a 3-wire conductor

Tone 1

Tone 2

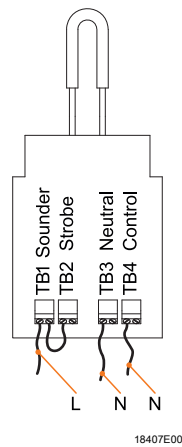
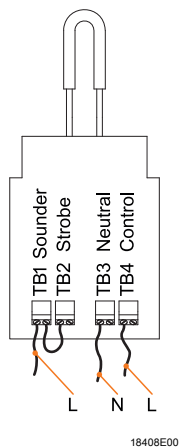

Independent function of sounder and strobe

Connection to a 3-wire conductor



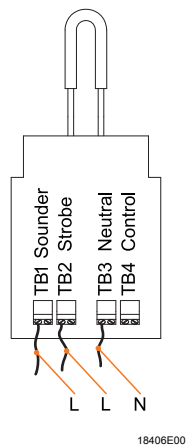

Second tone via connection to TB4 possible (see above).

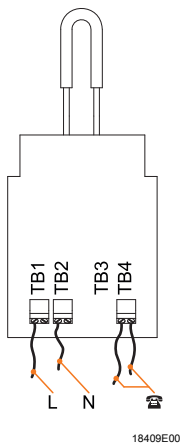

Combined function of sounder and strobe - activation by telephone signal

Sounder and strobe are activated by a telephone signal. The function is retained as long as the telephone signal is available. The strobe can flash up to four times after deactivating the telephone signal.



-  = Strobe
-  = Sounder
-  = Earth
-  = Sounder Tone
-  = Telephone initiate

7.2.5 Earth connection

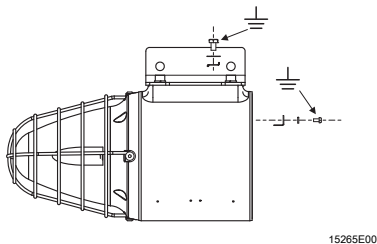

- The unit must be connected to a good quality earth.
- The internal Earth connection is the primary point. The external connection is for a supplementary bonding connection and is used where local code or authorities permit or require such connection.

7.2.6 Sound tone selection

- For signal tone selection and its switch positions refer to the table below.
- Check if the correct switch positions of the selected signal tones have been selected.

| Tone table | | | | | |
|------------|------------------------------|-----------|---------------------------------------|-----------------------|------------------------------------|
| Tone no. | Version | Frequency | Sound selection switch 12345 (ON = 1) | Repetition rate (sec) | Special application |
| Tone 01 | Alternate two-tone | 800-1000 | 11111 | 0.5 | Fire alarms - Level crossing |
| Tone 02 | Alternate two-tone | 2500-3100 | 01111 | 0.5 | Security alarms |
| Tone 03 | Alternate fast two-tone | 800-1000 | 10111 | 0.25 | Increased urgency - Level crossing |
| Tone 04 | Alternate fast two-tone | 2500-3100 | 00111 | 0.25 | Security deterrent |
| Tone 05 | Alternate two-tone | 440-554 | 11011 | 0.4/0.1 | AFNOR, France |
| Tone 06 | Alternate two-tone | 430-470 | 01011 | 1.0 | |
| Tone 07 | Alternate very fast two-tone | 800-1000 | 10011 | 0.13 | |
| Tone 08 | Alternate very fast two-tone | 2500-3200 | 00011 | 0.07 | |
| Tone 09 | Alternate two-tone | 440-554 | 11101 | 2.0 | Turn out, Sweden (SS 031711) |
| Tone 10 | Continuous tone | 700 | 01101 | | All clear, Sweden (SS 031711) |
| Tone 11 | Continuous tone | 1000 | 10101 | | |
| Tone 12 | Continuous tone | 1000 | 00101 | | |
| Tone 13 | Continuous tone | 2300 | 11001 | | |
| Tone 14 | Continuous tone | 440 | 01001 | | |
| Tone 15 | Interrupted tone | 1000 | 10001 | 2.0 | |
| Tone 16 | Interrupted tone | 420 | 00001 | 1.25 | AS2220, Australia |
| Tone 17 | Interrupted tone | 1000 | 11110 | 0.5 | |
| Tone 18 | Interrupted tone | 2500 | 01110 | 0.25 | |
| Tone 19 | Interrupted tone | 2500 | 10110 | 0.5 | |

| Tone table | | | | | |
|------------|----------------------------------|----------|-------|-------------|---------------------------------|
| Tone 20 | Interrupted tone | 700 | 00110 | 6/12 | Important message, Sweden |
| Tone 21 | Interrupted tone | 1000 | 11010 | 1.0 | |
| Tone 22 | Interrupted tone | 700 | 01010 | 4.0 | Air-raid alarm, Sweden |
| Tone 23 | Interrupted tone | 700 | 10010 | 0.25 | Local warning, Sweden |
| Tone 24 | Interrupted tone | 720 | 00010 | 0.7/0.3 | Industrial alarm, Germany |
| Tone 25 | Interrupted, fast, rising volume | 1400 | 11100 | 0.25 | |
| Tone 26 | Fast siren | 250-1200 | 01100 | 0.085 | |
| Tone 27 | Rising constantly, falling | 1000 | 10100 | 10/40/10 | Industrial alarm, Germany |
| Tone 28 | ISO 8201 Evacuation | 800-1000 | 00100 | As standard | International evacuation alarm |
| Tone 29 | Fast whoop | 500-1000 | 11000 | 0.15 | |
| Tone 30 | Slow whoop | 500-1200 | 01000 | 4.5 | Evacuation, The Netherlands |
| Tone 31 | Reverse sweep | 1200-500 | 10000 | 1.0 | Fire alarm, Germany (DIN 33404) |
| Tone 32 | Siren | 500-1200 | 00000 | 3.0 | |

The PFEER sound signals recommended by UKOOA are:

- | | | |
|---------------|-----------------|---------------------------|
| General alarm | Sound signal 15 | Interrupted tone 1000 Hz |
| PAPA | Sound signal 31 | Reverse sweep 1200-500 Hz |
| Toxic gas | Sound signal 11 | Continuous tone 1000 Hz |

Sound selection switch detail

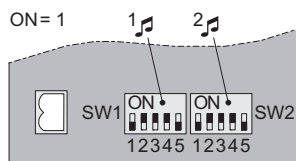

15268E00

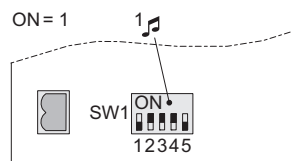

Standard



15269E00

Telephone initiate

7.3 Installation

| | |
|---|--|
|  | <p style="text-align: center;">WARNING</p> <p>Danger of electric shock due to energised parts! Non-compliance can result in severe or fatal injuries.</p> <ul style="list-style-type: none"> • All connections and wiring must be disconnected from the power supply. • Secure the connections against unauthorized switching. |
|  | <p style="text-align: center;">DANGER</p> <p>Explosion hazard! Risk of injuries and material damage!</p> <ul style="list-style-type: none"> • Operate the device only if it is not damaged. • If the thread is damaged, the device must be replaced immediately. • Handle the device and the components very carefully. • Exposed joint surfaces must be protected from dust, dirt and damage. • Mount the end flanges squarely and do not apply any force. • Do not use a hammer or any other metal instruments to work on the flange. • Do not use the fixing screws to pull down the flange. • Install the device only in a clean and dry operating environment. |

8 Commissioning

| | |
|---|--|
|  | <p style="text-align: center;">DANGER</p> <p>Explosion hazard due to incorrect installation! Non-compliance results in severe or fatal injuries.</p> <ul style="list-style-type: none"> • Check the device for proper installation and function before commissioning. • Comply with the national regulations. |
|---|--|

Before commissioning, ensure the following:

- the device has been installed according to regulations.
- the power supply voltage and the rated operational voltage are identical.
- the required cable diameter for cable glands has been used.
- the cable entries and stopping plugs have been securely tightened.
- the cables are correctly connected.
- the connection has been performed correctly.
- all screws and nuts are tightened according to regulations.
- the connection chamber is clean.
- the device is not damaged.
- no foreign bodies are inside the device.
- the device is sealed according to regulations.

9 Operation

The device is used to warn and alert by means

- of a sound signal.
- of a visual signal.

9.1 Troubleshooting

If an error occurs please re-visit the earlier sections of this document.

If the error cannot be eliminated using the mentioned procedures:

- Contact R. STAHL Schaltgeräte GmbH.

For fast processing, have the following information ready:

- Type and serial number
- Purchase information
- Error description
- Intended use (in particular input / output wiring)

10 Maintenance, overhaul, repair

| | |
|---|--|
|  | WARNING |
| | <p>Risk of electric shock or malfunctioning of the device due to unauthorized work!</p> <p>Non-compliance can result in severe injuries and material damage.</p> <ul style="list-style-type: none"> • Work performed on the device must only be carried out by appropriately authorized and qualified electricians. |

10.1 Maintenance

| | |
|---|--|
|  | Observe the relevant national regulations in the country of use. |
|---|--|

- Determine the type and extent of inspections in compliance with the relevant national regulations.
- Adapt inspection intervals to the operating conditions.

The following tests and measures must be carried out during regular maintenance.

Check

the permissible ambient temperature

the enclosure components for formation of cracks and damage.

its intended use

if the conductors are clamped properly
the cables for ageing and damage

the seals for ageing and damage

Measures

If exceeding the permissible ambient temperature or falling below the device must be taken out of operation.

Replace the exchangeable enclosure components. If the enclosure components are non-exchangeable, the device must be taken out of operation.

If the device is not used according to its intended use, it must be taken out of operation.

clamp loose conductors tightly.
replace damaged or aged cables.

replace damaged, aged and porous seals and completely change enclosure components with foamed seal.

10.2 Repair

| | |
|---|--|
|  | DANGER |
| | <p>Explosion hazard due to improper repair! Non-compliance results in severe or fatal injuries.</p> <ul style="list-style-type: none"> • Repair work on the devices must be performed only by R. STAHL Schaltgeräte GmbH. |

10.3 Returning the device

- Only return or package the devices after consulting R. STAHL!
Contact the responsible representative from R. STAHL.

R. STAHL's customer service is available to handle returns if repair or service is required.

- Contact customer service personally.

or

- Go to the www.r-stahl.com website.
- Under "Support" > "RMA form", select "Request RMA slip".
- Fill out the form and send it.
Confirmation will be sent. R. STAHL's customer service will contact you.
You will receive an RMA slip after speaking with customer service.
- Send the device along with the RMA slip in the packaging to
R. STAHL Schaltgeräte GmbH (refer to Section 1.1 for the address).

11 Cleaning

- Clean the device only with a cloth, brush, vacuum cleaner or similar items.
- When cleaning with a damp cloth, use water or mild, non-abrasive, non-scratching cleaning agents.
- Do not use aggressive detergents or solvents.

12 Disposal

- Observe national and local regulations and statutory regulation regarding disposal.
- Separate materials when sending it for recycling.
- Ensure environmentally friendly disposal of all components according to the statutory regulations.

13 Accessories and spare parts

| <i>NOTICE</i> | |
|--|--|
| <p>Malfunction or damage to the device due to the use of non-original components. Non-compliance can result in material damage.</p> <ul style="list-style-type: none"> • Use only original accessories and spare parts from R. STAHL Schaltgeräte GmbH. | |
|  | <p>For accessories and spare parts, see data sheet on our homepage www.r-stahl.com.</p> |

EG/EU-Konformitätserklärung
EC/EU Declaration of Conformity
Déclaration de Conformité CE/UE



R. STAHL Schaltgeräte GmbH • Am Bahnhof 30 • 74638 Waldenburg, Germany
 erklärt in alleiniger Verantwortung, *declares in its sole responsibility, déclare sous sa seule responsabilité,*

dass das Produkt: **Explosionsgeschütztes Kombinationssignal - 110 dB(A) / 5 Joule**
that the product:
que le produit: *Explosion Proof Combination Signal - 110 dB(A) / 5 Joule*
Avertisseur sonore et lumineux - 110 dB(A) / 5 joules

Typ(en), type(s), type(s): **YL60B**

mit den Anforderungen der folgenden Richtlinien und Normen übereinstimmt.
is in conformity with the requirements of the following directives and standards.
est conforme aux exigences des directives et des normes suivantes.

| Richtlinie(n) <i>Directive(s)</i> <i>Directive(s)</i> | | Norm(en) <i>Standard(s)</i> <i>Norme(s)</i> |
|--|---|--|
| Bis/Until/Jusque 2016-04-19: | Ab/From/De 2016-04-20: | EN 60079-0:2012 + A11:2013 EN 60079-1:2014 EN 60079-31: 2014 |
| 94/9/EG: ATEX-Richtlinie | 2014/34/EU: | |
| 94/9/EC: <i>ATEX Directive</i> | 2014/34/EU: | |
| 94/9/CE: <i>Directive ATEX</i> | 2014/34/UE: | |
| Kennzeichnung, marking, marquage: | | II 2 G Ex d IIB T* Gb CE 0158 II 2 D Ex tb IIIC T***°C Db |
| EG-Baumusterprüfbescheinigung: <i>EC Type Examination Certificate:</i> <i>Attestation d'examen CE de type:</i> | | Baseefa 02 ATEX 0212X (Baseefa Ltd., Rockhead Business Park Staden Lane, Buxton Derbyshire, SK17 9RZ United Kingdom) |
| Produktnormen nach Niederspannungsrichtlinie: <i>Product standards according to Low Voltage Directive:</i> <i>Normes des produit pour la Directive Basse Tension:</i> | | EN 60947-1: 2007 + A1: 2011/A2:2014 |
| Bis/Until/Jusque 2016-04-19: | Ab/From/De 2016-04-20: | EN 61000-6-1: 2007 EN 61000-6-2: 2006 EN 61000-6-3: 2007 + A1: 2011 / AC:2012 EN 61000-6-4: 2007 + A1: 2011 |
| 2004/108/EG: EMV-Richtlinie | 2014/30/EU: | |
| 2004/108/EC: <i>EMC Directive</i> | 2014/30/EU: | |
| 2004/108/CE: <i>Directive CEM</i> | 2014/30/UE: | |
| 2011/65/EU RoHS-Richtlinie | | EN 50581:2012 |
| 2011/65/EU <i>RoHS Directive</i> | | |
| 2011/65/UE <i>Directive RoHS</i> | | |

Waldenburg, 01.02.2016

Ort und Datum
Place and date
Lieu et date

i.V.

Dr. A. Kaufmann
Leiter BU Leuchten & Signalgeräte
Head of BU Lightings & Signalling
Directeur BU Eclairage & Appareils de Signal

i.V.

J.-P. Rückgauer
Leiter Qualitätsmanagement
Director Quality Management
Directeur Assurance de Qualité

EG/EU-Konformitätserklärung
EC/EU Declaration of Conformity
Déclaration de Conformité CE/UE



R. STAHL Schaltgeräte GmbH • Am Bahnhof 30 • 74638 Waldenburg, Germany
 erklärt in alleiniger Verantwortung, declares in its sole responsibility, déclare sous sa seule responsabilité,

dass das Produkt: **Explosionsgeschütztes Kombinationssignal - 110 dB(A)**
that the product: **/ 5 Joule**
que le produit: *Explosion Proof Combination Signal - 110 dB(A) / 5 Joule*
Avertisseur sonore et lumineux - 110 dB(A) / 5 joules

Typ(en), type(s), type(s): **YL60C**

mit den Anforderungen der folgenden Richtlinien und Normen übereinstimmt.
is in conformity with the requirements of the following directives and standards.
est conforme aux exigences des directives et des normes suivantes.

| Richtlinie(n) <i>Directive(s)</i> <i>Directive(s)</i> | | Norm(en) <i>Standard(s)</i> <i>Norme(s)</i> |
|--|---|---|
| Bis/Until/Jusque 2016-04-19: | Ab/From/De 2016-04-20: | EN 60079-0:2012 + A11:2013 EN 60079-1:2014 EN 60079-31: 2014 |
| 94/9/EG: ATEX-Richtlinie | 2014/34/EU: | |
| <i>94/9/EC: ATEX Directive</i> | <i>2014/34/EU:</i> | |
| <i>94/9/CE: Directive ATEX</i> | <i>2014/34/UE:</i> | |
| Kennzeichnung, marking, marquage: | | II 2 G Ex d IIB + H₂ T* Gb CE II 2 D Ex tb IIIC T***°C Db 0158 |
| EG-Baumusterprüfbescheinigung: <i>EC Type Examination Certificate:</i> <i>Attestation d'examen CE de type:</i> | | Baseefa 02 ATEX 0222X (Baseefa Ltd., Rockhead Business Park Staden Lane, Buxton Derbyshire, SK17 9RZ United Kingdom) |
| Produktnormen nach Niederspannungsrichtlinie: <i>Product standards according to Low Voltage Directive:</i> <i>Normes des produit pour la Directive Basse Tension:</i> | | EN 60947-1: 2007 + A1: 2011/A2:2014 |
| Bis/Until/Jusque 2016-04-19: | Ab/From/De 2016-04-20: | EN 61000-6-1: 2007 EN 61000-6-2: 2006 EN 61000-6-3: 2007 + A1: 2011 / AC:2012 EN 61000-6-4: 2007 + A1: 2011 |
| 2004/108/EG: EMV-Richtlinie | 2014/30/EU: | |
| <i>2004/108/EC: EMC Directive</i> | <i>2014/30/EU:</i> | |
| <i>2004/108/CE: Directive CEM</i> | <i>2014/30/UE:</i> | |
| 2011/65/EU RoHS-Richtlinie | | EN 50581:2012 |
| <i>2011/65/EU RoHS Directive</i> | | |
| <i>2011/65/UE Directive RoHS</i> | | |

Waldenburg, 01.02.2016

Ort und Datum
Place and date
Lieu et date

i.V.

Dr. A. Kaufmann
Leiter BU Leuchten & Signalgeräte
Head of BU Lightings & Signalling
Directeur BU Eclairage & Appareils de Signal

i.V.

J.-P. Rückgauer
Leiter Qualitätsmanagement
Director Quality Management
Directeur Assurance de Qualité