

## Technical data

eLLK 92018/18 NIB   eLLK 92036/36 NIB   eLLM 92018/18 NIB	
Marking to 94/9/EC	Ⓔ II 2 G Ex de mb ib IIC T4 / Ⓔ II 2 D Ex tD A21 IP66 T80 °C
EC-Type Examination Certificate	BVS 09 ATEX E 034
IECEX-Certificate of Conformity	IECEX BVS 09.0033
Marking to IECEX	Ex de mb [ib] IIC T4 Ex tD A21 IP66 T80 °C
Permissible ambient temperature	-25 °C to +50 °C (specified data: -5 °C to +35 °C)
Rated voltage	220 - 254 V AC
Rated voltage (option)	110 - 127 V AC
Frequency	50 - 60 Hz
Power factor cos φ	≥ 0.95
Circuit	EVG with emergency lighting supply
Insulation class	I
Lamp cap	G13 accd. to IEC 60081
Light efficiency in operation	78 %
Battery	Battery set with 7 Ah-NC battery, with LED display and monitoring via microprocessor
Rated emergency lighting operation	1-lamps can be set on site for an emergency lighting duration of 1.5 or 3 hours
Charging duration	> 14 h
Degree of protection accd. EN 60529	IP66
Cable glands/gland plates/enclosure drilling	Ex-e cable glands M25 x 1.5 (plastic) for cables from Ø 8 - 17 mm, Option: M20 x 1.5 metal thread (eLLK 92 NIB)
Enclosure material	Glass-fibre reinforced polyester
Protective cover/protective bowl	Polycarbonate

	eLLK 92018/18 NIB	eLLK 92036/36 NIB	eLLM 92018/18 NIB
Rated current	0.23 A	0.40 A	0.23 A
Connecting terminals	L1, L2, L3, L, N, PE; max. 2 x 6 mm <sup>2</sup> per terminal	L1, L2, L3, L, N, PE; max. 2 x 6 mm <sup>2</sup> per terminal	L1, L2, L3, L, N, PE; max. 2 x 6 mm <sup>2</sup> per terminal
Lamp/illuminant	2 x T26 / 18 W (T8)	2 x T26 / 36 W (T8)	2 x T26 / 18 W (T8)
Rated luminous flux <sup>1)</sup>	2700 lm	6700 lm	2700 lm
Luminous flux in emergency operation (1.5 h, one lamp) <sup>1)</sup>	1215 lm (90 %)	1507 lm (45 %)	1215 lm (90 %)
Luminous flux in emergency operation (3 h, one lamp) <sup>1)</sup>	607 lm (45 %)	873 lm (25 %)	607 lm (45 %)
Dimensions (L x W x H)	900 x 188 x 130 mm	1500 x 188 x 130 mm	1205 x 188 x 130 mm
Pole socket			Ø 44 x 150 mm
Weight	approx. 8.8 kg	approx. 12 kg	approx. 10.5 kg

<sup>1)</sup> depends on used lamps

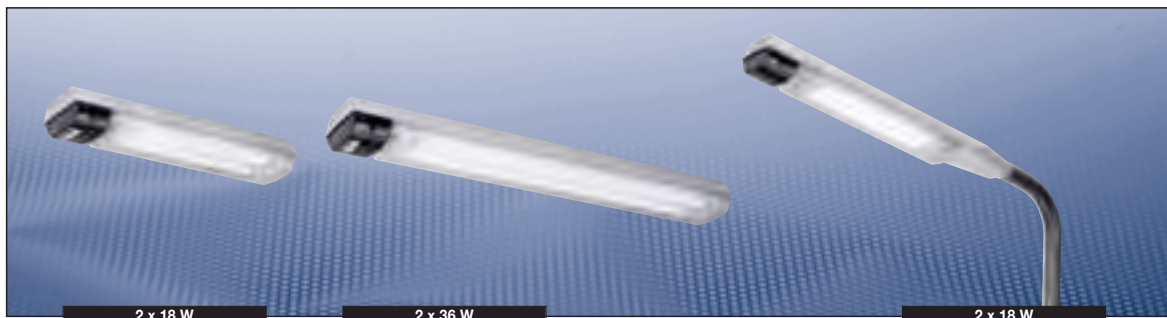

## Ordering details

Type	Terminals	Through-wiring single-ended	double-ended	Cable glands <sup>2)</sup>	Plugs	Order No.
<b>eLLK 92018/18 NIB (2 x 18 W)</b>						
1/6-1	1 x 6	x	–	2 x M25 x 1.5	1 x blanking	<b>1 2260 879 101</b>
2/6-2	2 x 6	–	x	2 x M25 x 1.5	2 x threaded	<b>1 2260 879 103</b>
2/6-2 M <sup>1)</sup>	2 x 6	–	x	4 x M20 x 1.5	3 x threaded	<b>1 2260 879 111</b>
<b>eLLK 92036/36 NIB (2 x 36 W)</b>						
1/6-1	1 x 6	x	–	2 x M25 x 1.5	1 x blanking	<b>1 2261 879 101</b>
2/6-2	2 x 6	–	x	2 x M25 x 1.5	2 x threaded	<b>1 2261 879 103</b>
2/6-2 M <sup>1)</sup>	2 x 6	–	x	4 x M20 x 1.5	3 x threaded	<b>1 2261 879 111</b>
<b>eLLM 92018/18 NIB (2 x 18 W)</b>						
2/6-1	1 x 8	x	–	1 x M25	–	<b>1 2273 879 101</b>

<sup>1)</sup> M: with metal thread, without cable gland

<sup>2)</sup> With dustcover if entry/thread is not closed

**Scope of delivery without lamp and fixing accessoires**

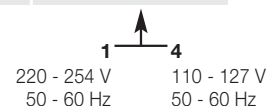

## Accessories

### Lamp for luminaire eLLK92... NIB/eLLM92... NIB

Type of lamp socket/ Diameter	Power	Luminous flux Light colour	Order No.
Bi-pin socket G13 T26/Ø 26 mm (T8) G13-60081-IEC-2220-1	18 W	1350 lm white	<b>3 2475 900 001</b>
Bi-pin socket G13 T26/Ø 26 mm (T8) G13-60081-IEC-2420-1	36 W	3350 lm white	<b>3 2475 900 002</b>
Aura-Ultimate T26/Ø 26 mm (T8) Longlife Socket G13	18 W 36 W	1300 lm white 3350 lm white	<b>3 2475 900 087</b> <b>3 2475 900 088</b>
Aura Super Ex T-HS 26/Ø 26 mm <sup>1)</sup> Single pin cap Fa6	18 W 36 W	1150 lm white 3000 lm white	<b>3 2475 900 084</b> <b>3 2475 900 085</b>

<sup>1)</sup> For luminaires eLLK 923../.. and eLLM 923../.. single-pin caps Fa6

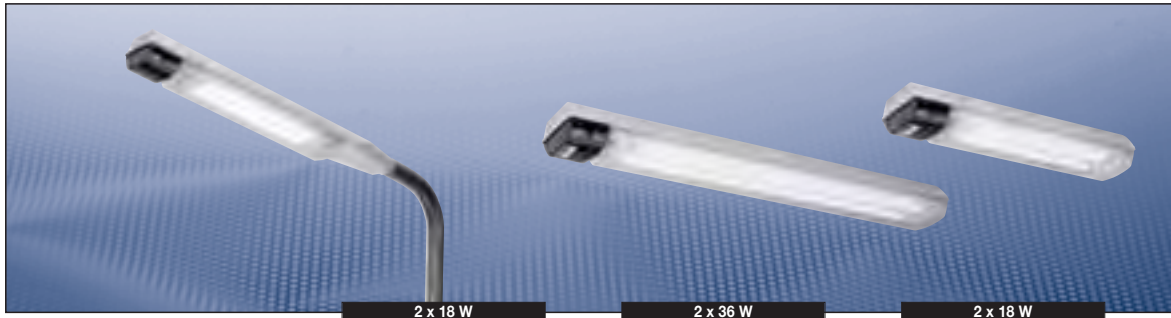

## Accessories

### Series eLLK 92... NIB and eLLM 92... NIB

Type	Order No.
Hexagon key SW 13	3 2485 000 005

### Series eLLM 92018/18 NIB and eLLM 92036/36 NIB

Type	Order No.
Single sided through wiring 2/6 with 2 entries M25, incl. terminals and mounting material	2 2218 602 000

### Fixing materials eLLK 92... NIB

Type/code	Corrosion protection	Qty. per light fitting	Order No.
Eye bolt A2	galvanized	2	2 2480 002 000
Hexagon screw S4	stainless steel	2	2 2480 054 000
Ceiling mounting bracket D92 incl. screws and washer	stainless steel	2	2 2480 092 000

### Fixing materials

Type/code	Corrosion protection	for pipes DIN	Outer Ø D (mm)	Qty. per light fitting	Order No.
Pipe clamp					
R12	hot galvanized	1 1/4"	38 - 42	2	2 2480 462 000
R14	CrNi	1 1/4"	38 - 42	2	2 2480 464 000
R22	hot galvanized	1 1/2"	47 - 51	2	2 2480 472 000
R24	CrNi	1 1/2"	47 - 51	2	2 2480 474 000
R32	hot galvanized	2"	56 - 60	2	2 2480 482 000
R34	CrNi	2"	56 - 60	2	2 2480 484 000
Wall bracket W27	hot galvanized		42.4	1	2 2483 027 000
Luminaire wall suspension 30° incl. screws and washer	hot galvanized			2	2 2480 000 122

### Battery

Type	Order No.
eLLK 92..., eLLM 92... NIB Battery set type 2710-3 with LED display and micro-processor monitoring, complete	2 2710 904 000

<sup>1)</sup> For luminaires eLLK 923../.. and eLLM 923../.. with single pin caps Fa6

**Metal cable glands M20/M25 see page 8.10.**

**Complete Mounting Systems see page 2.70 to 2.76.**

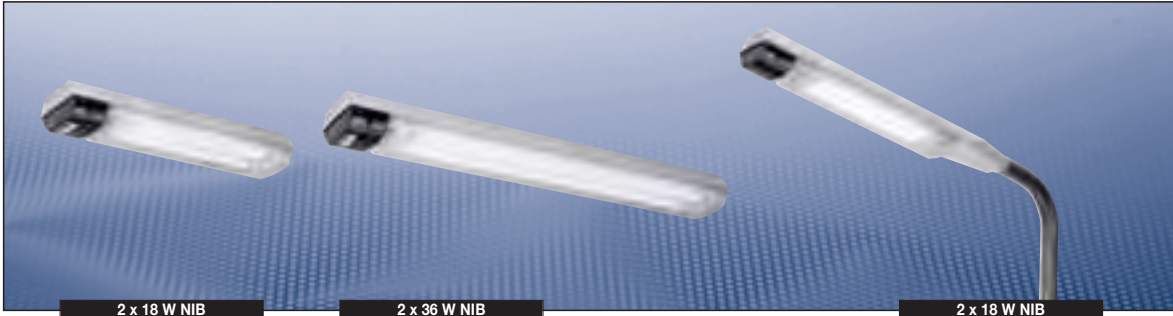

2 x 18 W NIB

2 x 36 W NIB

2 x 18 W NIB

**Dimension drawing | Polar curve**

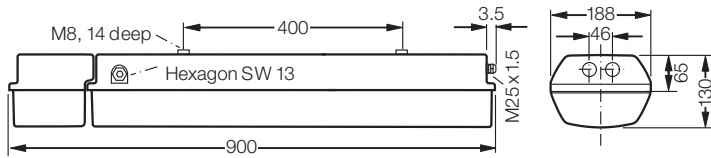

**eLLK 92018/18 NIB**

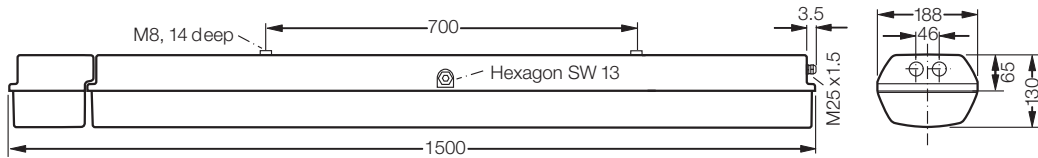

**eLLK 92036/36 NIB**

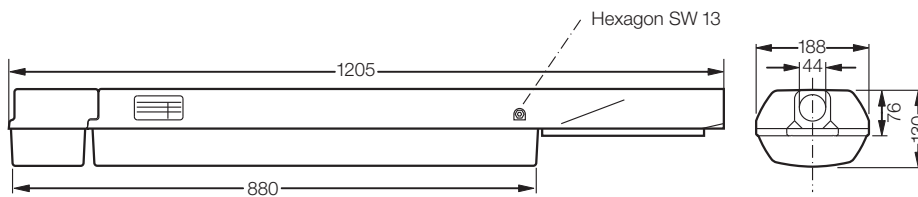

**eLLM 92018/18 NIB**

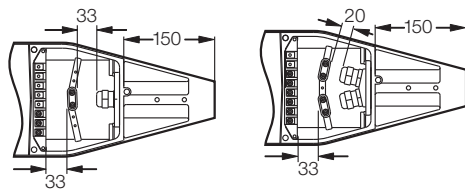

**eLLM 92018/18 NIB**

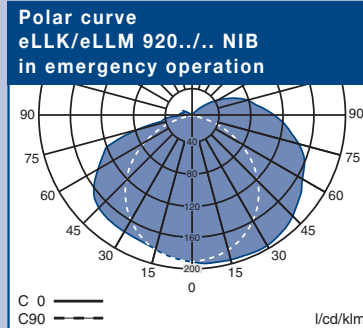
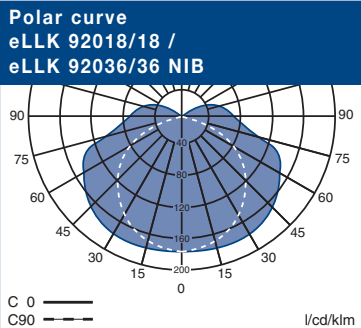

Dimensions in mm

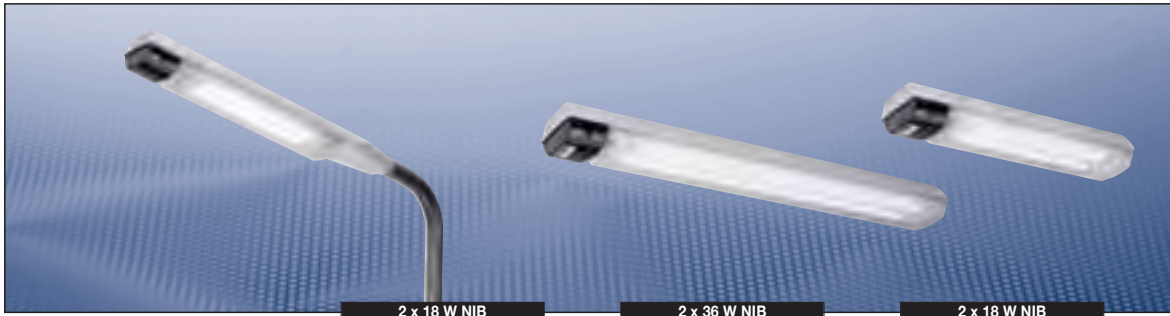

**Dimension drawing**

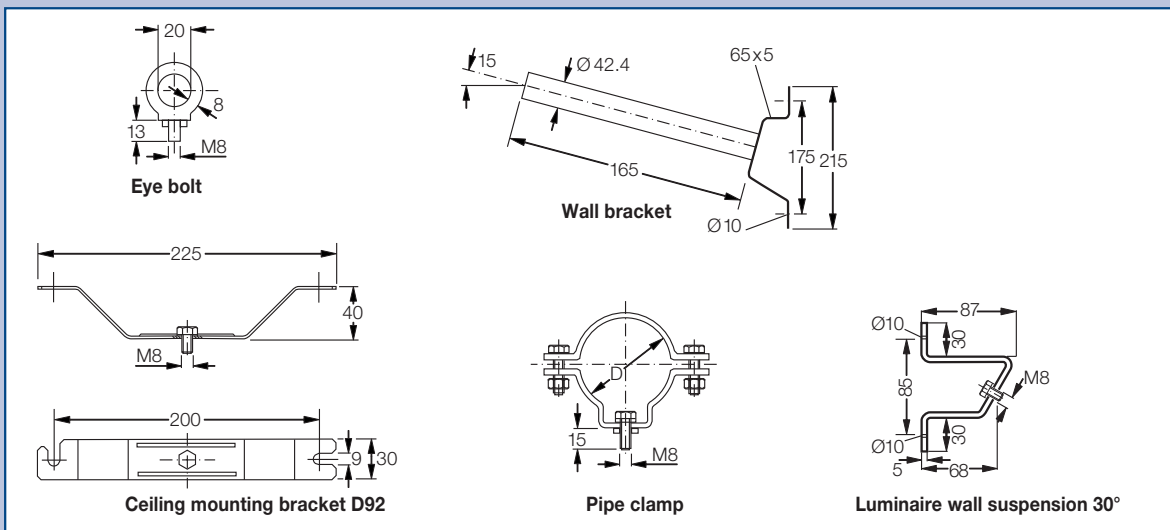

Dimensions in mm